

Inductive distance measuring sensors

IWRM 12U9704/S14

dimension drawing

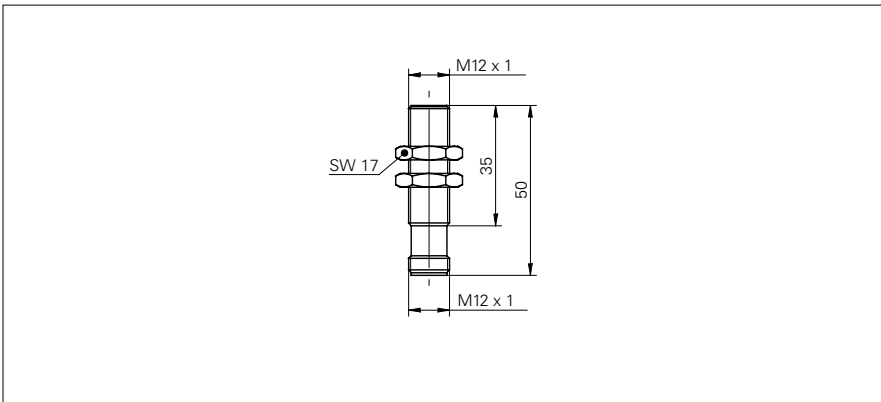

general data

mounting type	quasi-flush
measuring distance Sd	0 ... 4 mm
resolution	< 0,001 mm (stat.) < 0,005 mm (dynam.)
repeat accuracy	< 0,01 mm
linearity error	± 160 µm
temperature drift	± 4 % (Full Scale)

electrical data

response time (factory characteristic)	< 2 ms
voltage supply range +Vs	15 ... 30 VDC
current consumption max. (no load)	20 mA
output circuit	voltage output
output signal	0 ... 10 VDC
load resistance	> 1000 Ohm
short circuit protection	yes
reverse polarity protection	yes

mechanical data

type	cylindrical threaded
housing material	brass nickel plated
dimension	12 mm
housing length	50 mm
connection types	connector M12

ambient conditions

operating temperature	-10 ... +70 °C
protection class	IP 67

photo



connection diagram

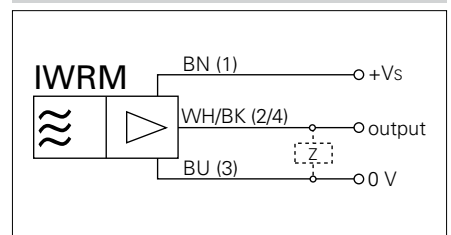

installation drawing

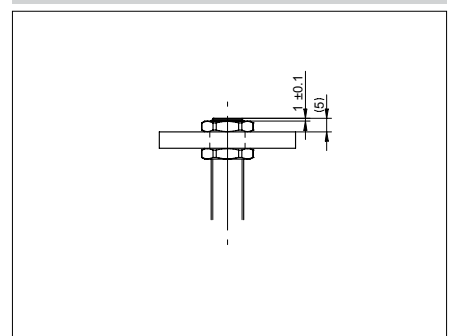

• linearity deviation (S = 0,5...4 mm) ± 4% (Full Scale)